

# Ignition Module Catalogue

	Page	
<b>Modules:</b> <b>Vehicle Application Guide</b>	<b>3 - 14</b>	<b>1</b>
<b>Pulse Generator:</b> <b>Vehicle Application Guide</b>	<b>15 - 22</b>	<b>2</b>
<b>Service Parts:</b> <b>Connector Plug Kits</b>	<b>23 - 26</b>	<b>3</b>
<b>Illustrated Guide:</b> <b>Modules</b> <b>Pulse Generators</b>	<b>27 - 31</b> <b>31 - 32</b>	<b>4</b>

Whilst every care is taken in the preparation of this catalogue, no responsibility is accepted either for correctness or completeness as many of the recommendations are compiled from field and trade information.

Information in this catalogue supersedes any previous listings.

**GOOD. BETTER. BOSCH**



# **Ignition Modules Vehicle Application Guide**

Make / Model	Series	From To	Cyl.	Ltr.	Engine	Type	Bosch Ignition Module	Notes
<b>ALFA ROMEO</b>								
<b>33</b>		87 - 88	4	1.7	AR 30550	Carb	BIM 123	Bosch Ignition
		88 - 89	4	1.7	AR 30550	Carb	BIM 140	Bosch Distributor mounted unit
<b>75</b>		88 - 92	4	2.0	AR 06224	Twin Spark	0 221 600 054	Coil & Module Assy
		86 - 90	6	2.5	AR 0911		BIM 123	Bosch Ignition
		88 - 92	6	3.0	AR 6124		BIM 123	Bosch Ignition
<b>90</b>		86 - 88	6	2.5	AR 0911		BIM 123	Bosch Ignition
<b>GTV</b>		81 - 86	4	2.0	AR 01623	Carb	BIM 123	Bosch Ignition
		86 - 88	6	2.5	AR 0911		BIM 123	Bosch Ignition
<b>Giulietta</b>		84 - 85	4	2.0	AR 01655	Carb	BIM 123	Bosch Ignition
<b>Sprint</b>		83 - 87	4	1.5	AR 30198	Carb	BIM 123	Bosch Ignition
<b>AUDI</b>								
<b>80</b>		83 - 86	4	1.8	JN		BIM 137	
		87 - 88	4	1.9	SD		BIM 137	
		88 - 90	4	2.0	3A		BIM 137	
		91 - 96	4	2.0	ABK		BIM 130	
		92 - 96	5	2.2	ABY		0 227 100 209	
		93 - 96	5	2.2	ADU		0 227 100 209	
		93 - 96	5	2.2	AAN	Turbo	0 227 100 209	
<b>90</b>		87 - 91	5	2.3	NG		0 221 600 050	Coil & Module Assy
<b>100</b>		77 - 82	5	2.2	WC/WE		BIM 137	
		82 - 84	5	2.2	KF		BIM 137	
		84 - 86	5	2.2	HX		BIM 137	
		86 - 89	5	2.2	HX		BIM 142	Replaces "Telefunken" unit
<b>A4</b>		94 - 98	4	1.8	ADR		BIM 901	
		94 - 98	4	1.8	AEB	Turbo	0 227 100 211	Power Transistor unit
		94 - 97	6	2.6	ABC		0 227 100 209	Two Units used
<b>A6</b>		94 - 97	6	2.6	ABC		0 227 100 209	Two Units used
<b>A8</b>		94 - 98	8	3.7	AEW		0 227 100 211	Power Transistor unit (2 used)
		94 - 98	8	4.2	ABZ		0 227 100 211	Power Transistor unit (2 used)
<b>BMW</b>								
<b>318</b>	E21	80 - 83	4	1.8	184EZ	K-Jetronic	BIM 123	
<b>323</b>	E21	78 - 80	6	2.3	236EA	K-Jetronic	BIM 025	Metal Housing unit
	E21	80 - 83	6	2.3	236EA	K-Jetronic	BIM 123	
<b>520</b>	E28	81 - 84	6	2.0	206EA	K-Jetronic	BIM 123	
<b>528</b>	E28	81 - 87	6	2.8	286EA	EFI	BIM 123	
<b>633</b>	E24	78 - 81	6	3.2	326EA	L-Jetronic	BIM 025	Metal Housing unit
<b>733</b>	E23	78 - 81	6	3.2	326EA	L-Jetronic	BIM 025	Metal Housing unit
<b>K100</b>		89 - 92	4	1.0			BIM 200	



Make / Model	Series	From To	Cyl.	Ltr.	Engine	Type	Bosch Ignition Module	Notes
<b>BMW cont.d</b>								
K1100		92 - 99	4	1.1			BIM 200	
R100		87 - 96	4	1.0			BIM 137	
<b>CITREON</b>								
AX		91 - 92	4	1.4	KDZ		BIM 140	3 pin Bosch Module
BX	16	84 - 88	4	1.6	BAY	Carb	BIM 123	6 pin Bosch Module
	16	88 - 89	4	1.6	BAY	Carb	BIM 140	3 pin Bosch Module
	19	86 - 89	4	1.9	D2E	Carb	BIM 123	6 pin Bosch Module
	19	89 - 93	4	1.9	D2F	Carb	BIM 140	3 pin Bosch Module
	19	89 - 94	4	1.9	DFW	EFI 16 valve	BIM 123	6 pin Bosch Module
Xantia	X1	95 - 98	4	2.0	RGX	Turbo	BIM 200	
XM	Y3	89 - 97	6	3.0	SFZ		BIM 124	
	Y4	97 - 98	6	3.0	UKZ	24 valve	BIM 124	
<b>DAEWOO</b>								
1.5i		94 - 95	4	1.5			BIM 148	Delco Ignition
Cielo		95 - 98	4	1.5			BIM 148	Delco Ignition
Espero		95 - 98	4	2.0			BIM 148	Delco Ignition
<b>DAIHATSU</b>								
Applause	A101	90 - 97	4	1.6	HD-E	EFI	BIM 076	Mitsubishi # J 152
<b>EUNOS</b>								
30X		91 - 98	6	1.8	KF	Quad cam	BIM 089	Mitsubishi # J 885
500		92 - 98	6	2.0	KF	Quad cam	BIM 089	Mitsubishi # J 885
800		93 - 98	6	2.5	KL	Quad cam	BIM 089	Mitsubishi # J 885
<b>FIAT</b>								
Argenta		81 - 83	4	2.0	132FB	Carb & EFI	BIM 014	Bosch Ignition
<b>FORD - 4 Cyl.</b>								
Capri	SA	89 - 90	4	1.6	B6	SOHC	BIM 075	Mitsubishi # J 117
	SA	90 - 92	4	1.6	B6T	DOHC Turbo	BIM 078	Mitsubishi # J 911
	SC	92 - 93	4	1.6	B6	SOHC	BIM 075	Mitsubishi # J 117
	SC	92 - 93	4	1.6	B6T	DOHC Turbo	BIM 078	Mitsubishi # J 911
	SC	92 - 93	4	1.8	BPD	DOHC	BIM 101	Mitsubishi # J 207 "5 pin" unit
	SE	92 - 93	4	1.6	B6T	DOHC Turbo	BIM 078	Mitsubishi # J 911
	SE	92 - 93	4	1.8	BPD	DOHC	BIM 101	Mitsubishi # J 207 "5 pin" unit
Corsair	UA	89 - 92	4	2.0	CA20E		BIM 034	2 Used
	UA	89 - 92	4	2.4	KA24E		BIM 091	
Courier		87 - 92	4	2.2		Carb	BIM 075	Mitsubishi # J 117
		87 - 90	4	2.6		Carb	BIM 078	Mitsubishi # J 911
	PC	90 - 96	4	2.6		EFI	BIM 085	Mitsubishi # J 701
	PD	96 - 02	4	2.6		EFI	BIM 085	Mitsubishi # J 701
Econovan		84 - 96	4	1.8,2.0		Carb (auto)	BIM 073	Mitsubishi # J 106

Make / Model	Series	From To	Cyl.	Ltr.	Engine	Type	Bosch Ignition Module	Notes
<b>Ford - 4 CYL. cont.d</b>								
<b>Econovan</b>		86 - 96	4	1.8,2.0		Carb (man)	BIM 075	Mitsubishi # J 117
	JG	96 - 99	4	2.0		Carb	BIM 075	Mitsubishi # J 117
	JH	99 - 02	4	2.0		Carb	BIM 075	Mitsubishi # J 117
<b>Laser</b>	KB	82 - 85	4	1.3,1.5		Carb (inc twin)	BIM 073	Mitsubishi # J 106
	KC	85 - 87	4	1.3	B3	Carb	BIM 073	Mitsubishi # J 106
	KC	85 - 87	4	1.6	B6	Carb	BIM 075	Mitsubishi # J 117
	KC	85 - 87	4	1.6	B6	EFI	BIM 073	Mitsubishi # J 106
	KE	87 - 90	4	1.3	B3	Carb	BIM 073	Mitsubishi # J 106
	KE	87 - 90	4	1.6	B6	Carb	BIM 075	Mitsubishi # J 117
	KE	87 - 90	4	1.6	B6	EFI	BIM 075	Mitsubishi # J 117
	KE	87 - 90	4	1.6	B6T	Turbo	BIM 078	Mitsubishi # J 911
	KF	90 - 91	4	1.6	B6	SOHC - carb	BIM 088	Mitsubishi # J 170
	KF	90 - 91	4	1.8	BPD	SOHC	BIM 085	Mitsubishi # J 701
	KH	91 - 94	4	1.6	B6	SOHC - carb	BIM 088	Mitsubishi # J 170
	KH	91 - 94	4	1.8	BPD	SOHC	BIM 085	Mitsubishi # J 701
	<b>Meteor</b>	GB	82 - 85	4	1.5		Carb (all)	BIM 073
GC		85 - 87	4	1.6		Carb	BIM 075	Mitsubishi # J 117
GC		85 - 87	4	1.6		EFI	BIM 073	Mitsubishi # J 106
<b>Raider</b>	PC	90 - 96	4	2.6		EFI	BIM 085	Mitsubishi # J 701
<b>Telstar</b>	AR	83 - 85	4	2.0		Carb	BIM 073	Mitsubishi Distributor
	AS	85 - 87	4	2.0		Carb	BIM 024	Bosch Distributor
<b>FORD - 6 Cyl.</b>								
<b>Bronco</b>		81 - 85	6	4.1		Carb	BIM 024	Alloy Head Only
<b>Cortina</b>	TE	77 - 80	6	3.3,4.1			BIM 024	Alloy Head Only
	TF	80 - 83	6	3.3,4.1			BIM 024	Alloy Head Only
<b>F-Series</b>		81 - 85	6	4.1		Carb	BIM 024	Alloy Head Only
<b>Falcon Incl. Utility</b>	XD	79 - 82	6	3.3,4.1			BIM 024	Alloy Head Only
	XE	82 - 84	6	3.3,4.1			BIM 024	
	XF	84 - 86	6	3.3,4.1		Carb	BIM 024	Leaded Fuel Only
	XF	84 - 88	6	4.1		EFI	BIM 032	
	EA	88 - 91	6	3.2,3.9		CFI/MPFI	BIM 032	
	EB	91 - 92	6	3.9		CFI/MPFI	BIM 032	
	EB-II	92 - 93	6	4.0		MPFI	BIM 032	
	ED	93 - 94	6	4.0		MPFI	BIM 032	
	EL	96 - 98	6	4.0		MPFI	BIM 032	
	XG	93 - 96	6	4.0		MPFI	BIM 032	
XH	96 - 98	6	4.0		MPFI	BIM 032		
<b>Fairlane</b>	ZJ	79 - 82	6	4.1			BIM 024	
	ZK	82 - 84	6	4.1		Carb & EFI	BIM 024	
	ZL	84 - 86	6	4.1		Carb	BIM 024	Leaded Fuel Only
	ZL	84 - 88	6	4.1		EFI	BIM 032	
	NA	88 - 91	6	3.9		MPFI	BIM 032	
	NC	91 - 92	6	3.9		MPFI	BIM 032	
	NC-II	92 - 94	6	4.0		MPFI	BIM 032	
NL	96 - 98	6	4.0		MPFI	BIM 032		
<b>LTD</b>	FC	79 - 82	6	4.1			BIM 024	
	FD	82 - 84	6	4.1		Carb & EFI	BIM 024	
	FE	84 - 86	6	4.1		Carb	BIM 024	Leaded Fuel Only



Make / Model	Series	From To	Cyl.	Ltr.	Engine	Type	Bosch Ignition Module	Notes
<b>FORD - 6 cyl. cont.d</b>								
<b>LTD</b>	FE	84 - 88	6	4.1		EFI	BIM 032	
	DA	88 - 91	6	3.9		MPFI	BIM 032	
	DC	91 - 92	6	3.9		MPFI	BIM 032	
	DC-II	92 - 94	6	4.0		MPFI	BIM 032	
	DL	96 - 98	6	4.0		MPFI	BIM 032	
<b>Telstar</b>	AX	91 - 94	6	2.5	KL	Quad cam	BIM 089	Mitsubishi # J 885
	AY	94 - 95	6	2.5	KL	Quad cam	BIM 089	Mitsubishi # J 885
<b>FORD - 8 Cyl.</b>								
<b>Bronco</b>		81 - 85	8	4.9,5.0		Carb	BIM 024	
		85 - 93	8	5.0,5.8		EFI	BIM 032	
<b>F-Series</b>		81 - 85	8	4.9,5.0		Carb	BIM 024	
		85 - 93	8	5.0,5.8		EFI	BIM 032	
<b>Falcon Incl. Utility</b>	XC	76 - 79	8	5.8			BIM 127	
	XD	79 - 82	8	4.9,5.8			BIM 024	
	XE	82 - 84	8	4.9,5.8			BIM 024	
	EB	91 - 92	8	5.0		SEFI	BIM 032	
	EB-II	92 - 93	8	5.0		SEFI	BIM 032	
	ED	93 - 94	8	5.0		SEFI	BIM 032	
	EF	94 - 96	8	5.0		SEFI	BIM 032	
	EL	96 - 98	8	5.0		SEFI	BIM 032	
	XH	96 - 98	8	5.0		SEFI	BIM 032	
<b>Fairlane</b>	ZH	76 - 79	8	5.8			BIM 127	
	ZJ	79 - 82	8	4.9,5.8			BIM 024	
	ZK	82 - 84	8	4.9,5.8			BIM 024	
	NC-II	92 - 94	8	5.0		SEFI	BIM 032	
	NF	94 - 96	8	5.0		SEFI	BIM 032	
	NL	96 - 98	8	5.0		SEFI	BIM 032	
<b>LTD</b>	P6 [XC]	76 - 79	8	5.8			BIM 127	
	FC	79 - 82	8	4.9,5.8			BIM 024	
	FD	82 - 84	8	4.9,5.8			BIM 024	
	DC-II	02 - 94	8	5.0		SEFI	BIM 032	
	DF	94 - 96	8	5.0		SEFI	BIM 032	
	DL	96 - 98	8	5.0		SEFI	BIM 032	
<b>HOLDEN - 4 Cyl.</b>								
<b>Apollo</b>	JK	87 - 91	4	2.0	3SF-C	Carb	BIM 904	
<b>Astra</b>	LD	87 - 90	4	1.6	16LE	TBI	BIM 148	Delco Ignition
	LD	87 - 90	4	1.8	18LF	PFI	BIM 148	Delco Ignition
<b>Barina</b>	MF	88 - 93	4	1.3	G13A	Carb	BIM 075	Mitsubishi # J117
<b>Calibra</b>	YE	91 - 97	4	2.0	C20NE	DOHC (16v)	BIM 200	
	YE	91 - 97	4	2.0	C20XE	SOHC	BIM 028	
	YE	91 - 97	4	2.0	C20LET	Turbo	BIM 028	
<b>Camira</b>	JB	82 - 83	4	1.6		Carb	BIM 023	
	JD	83 - 87	4	1.8	18JU	EFI	BIM 027	Bosch ignition
	JD	86 - 87	4	1.6		TBI	BIM 148	Delco Ignition
	JE	87 - 90	4	2.0		PFI	BIM 148	Delco Ignition

Make / Model	Series	From To	Cyl.	Ltr.	Engine	Type	Bosch Ignition Module	Notes
<b>HOLDEN - 4 Cyl. cont.d</b>								
Nova	LE	90 - 92	4	1.4	4AF-C	Carb	BIM 024	Bosch Distributor
	LE	90 - 92	4	1.6	6AF-C	Carb	BIM 024	Bosch Distributor
	LF	92 - 94	4	1.4	4AF-C	Carb	BIM 024	Bosch Distributor
	LF	92 - 94	4	1.6	6AF-C	Carb	BIM 024	Bosch Distributor
	LF	92 - 94	4	1.6	4AF-E	EFI	BIM 904	Denso Module
	LG	94 - 96	4	1.6	4AF-E	EFI	BIM 904	Denso Module
<b>HOLDEN - 6 Cyl.</b>								
Calais	VK	84 - 86	6	3.3		EFI	BIM 024	
	VN	88 - 91	6	3.8			BIM 801	
	VP	91 - 93	6	3.8			BIM 802	
	VR	93 - 95	6	3.8			BIM 802	
	VS	95 - 97	6	3.8		inc S/Charged	BIM 802	
	VT	97 - 00	6	3.8		inc S/Charged	BIM 802	
	VX	00 - 02	6	3.8		inc S/Charged	BIM 802	
Calibra	YE	93 - 97	6	2.5	C25XE		0 227 100 203	
Commodore [incl utility]	VC	81 - 83	6	2.85,3.3			BIM 024	
	VH	83 - 84	6	2.85,3.3			BIM 024	
	VK	84 - 86	6	3.3		EFI	BIM 024	
	VN	88 - 91	6	3.8			BIM 801	
	VG	90 - 91	6	3.8			BIM 802	
	VP	91 - 93	6	3.8			BIM 802	
	VR	93 - 95	6	3.8			BIM 802	
	VS	95 - 01	6	3.8		inc S/Charged	BIM 802	
	VT	97 - 00	6	3.8		inc S/Charged	BIM 802	
	VX	00 - 02	6	3.8		inc S/Charged	BIM 802	
	VU	01 - 02	6	3.8			BIM 802	
	WB	80 - 85	6	3.3			BIM 024	Ute & Van
Statesman	VQ-II	92 - 93	6	3.8			BIM 802	
	VR	93 - 95	6	3.8			BIM 802	
	VS	95 - 99	6	3.8		inc S/Charged	BIM 802	
	WH	99 - 02	6	3.8		inc S/Charged	BIM 802	
<b>HOLDEN - 8 Cyl.</b>								
Calais	VK	84 - 86	8	5.0		Carb	BIM 024	
	VL	86 - 88	8	5.0		Carb	BIM 024	
	VN	88 - 91	8	5.0		EFI	9 220 066 020	
	VP	91 - 93	8	5.0		EFI	9 220 066 020	
	VR	93 - 95	8	5.0		EFI	9 220 066 020	
	VS	95 - 97	8	5.0		EFI	9 220 066 020	
	VT	97 - 00	8	5.0		EFI	9 220 066 020	Series one V8 only
Commodore [incl utility]	VC	81 - 83	8	4.2,5.0			BIM 024	
	VH	83 - 84	8	4.2,5.0			BIM 024	
	VK	84 - 86	8	5.0		Carb	BIM 024	
	VL	86 - 88	8	5.0		Carb	BIM 024	
	VL	88 - 88	8	5.0		EFI	9 220 066 020	Walkinshaw GRP A
	VN	88 - 91	8	5.0		EFI	9 220 066 020	
	VG	90 - 91	8	5.0		EFI	9 220 066 020	
	VP	91 - 93	8	5.0		EFI	9 220 066 020	
	VR	93 - 95	8	5.0		EFI	9 220 066 020	
	VS	95 - 01	8	5.0		EFI	9 220 066 020	
	VT	97 - 00	8	5.0		EFI	9 220 066 020	Series one V8 only
WB	80 - 85	8	4.2,5.0			BIM 024	Ute & Van	





Make / Model	Series	From To	Cyl.	Ltr.	Engine	Type	Bosch Ignition Module	Notes
<b>HOLDEN - 8 cyl. cont.d</b>								
<b>Statesman</b>	WB	80 - 85	8	4.2,5.0			BIM 024	
	VQ	91 - 93	8	5.0		EFI	9 220 066 020	
	VR	93 - 95	8	5.0		EFI	9 220 066 020	
	VS	95 - 99	8	5.0		EFI	9 220 066 020	
<b>HONDA</b>								
<b>Accord</b>	AA	81 - 83	4	1.6	EL	Carb	BIM 902	External of Distributor
	AC	84 - 85	4	1.8	ET	Carb	BIM 902	External of Distributor
		90 - 93	4	2.2			EFI	BIM 079
<b>City</b>		83 - 86	4	1.2	ER	Carb	BIM 902	External of Distributor
<b>Concerto</b>		88 - 93	4	1.6	D16A6	DOHC	BIM 079	Internal unit
<b>CR-X</b>		86 - 88	4	1.6	D16A8	DOHC	BIM 902	External of Distributor
		88 - 91	4	1.6	D16A9	DOHC	BIM 079	Internal unit
<b>Integra</b>		86 - 89	4	1.6	D16A3	EFI 16v	BIM 079	Internal unit
<b>Legend</b>		86 - 87	6	2.5	CS25A1		BIM 902	External of Distributor
<b>Prelude</b>		86 - 91	4	2.0	B20A6	EFI	BIM 902	External of Distributor
		91 - 96	4	2.2	F22A1	SOHC	BIM 079	Internal unit
		91 - 96	4	2.3	H23A1	DOHC	BIM 079	Internal unit
<b>HYUNDAI</b>								
<b>Excel</b>	X1	87 - 90	4	1.5	G4AJ	Carb	BIM 076	Mitsubishi # J 152
	X2	90 - 91	4	1.5	G4DJK	Carb	BIM 076	Mitsubishi # J 152
	X2	91 - 94	4	1.5	G4DJ	EFI	BIM 034	Mitsubishi Power Unit J 121
<b>S-Coupe</b>		90 - 92	4	1.5	G4DJ	EFI	BIM 034	Mitsubishi Power Unit J 121
		90 - 92	4	1.5	G4AJ	EFI	BIM 207	4 pin power transistor
<b>Sonata</b>		89 - 90	4	2.4	G4CSK	EFI	BIM 034	Mitsubishi Power Unit J 121
		90 - 93	6	3.0	G6AT	EFI	BIM 034	Mitsubishi Power Unit J 121
<b>LADA</b>								
<b>Samara</b>		88 - 90	4	1.5	VAZ21083		BIM 023	
<b>MAZDA</b>								
<b>121</b>	DA	87 - 89	4	1.3	B3	Carb	BIM 075	Mitsubishi # J 117
<b>323 (inc Astina)</b>	BF	83 - 86	4	1.3	B3	Carb	BIM 073	Mitsubishi # J 106
	BF	83 - 86	4	1.5	B5	Carb	BIM 073	Mitsubishi # J 106
	BF	86 - 89	4	1.6	B6	Carb	BIM 075	Mitsubishi # J 117
	BF	86 - 89	4	1.6	B6	EFI	BIM 075	Mitsubishi # J 117
	BF	86 - 89	4	1.6	B6T	Turbo	BIM 078	Mitsubishi # J 911
	BG	89 - 96	4	1.8	BP	SOHC	BIM 078	Mitsubishi # J 911
	BG	89 - 96	4	1.8	BPD	DOHC	BIM 085	Mitsubishi # J 701
	BG	94 - 96	6	2.0	KF	Quad cam	BIM 089	Mitsubishi # J 885
<b>626 (inc MX-6)</b>	GB	83 - 85	4	2.0	FE	Carb	BIM 073	
	GC	85 - 87	4	2.0	FE	Carb	BIM 073	
	GE	91 - 95	6	2.5	KL	Quad cam	BIM 089	Mitsubishi # J 885
<b>929</b>	HB	84 - 87	4	2.0	FE	Carb	BIM 073	

Make / Model	Series	From To	Cyl.	Ltr.	Engine	Type	Bosch Ignition Module	Notes
<b>MAZDA cont.d</b>								
929	HC	87 - 90	6	3.0	JE	SOHC (18v)	BIM 101	Mitsubishi # J 207/208 5 pin unit
	HC	90 - 95	6	3.0	JE	DOHC (24v)	BIM 085	Mitsubishi # J 701
	HE	95 - 97	6	3.0	JE	DOHC (24v)	BIM 085	Mitsubishi # J 701
B-Series		87 - 92	4	2.2		Carb	BIM 075	Mitsubishi # J 117
		87 - 90	4	2.6		Carb	BIM 078	Mitsubishi # J 911
	PC	90 - 96	4	2.6		EFI	BIM 085	Mitsubishi # J 701
	PD	96 - 02	4	2.6		EFI	BIM 085	Mitsubishi # J 701
E-Series	JG	96 - 99	4	2.0		Carb	BIM 075	Mitsubishi # J 117
	JH	99 - 02	4	2.0		Carb	BIM 075	Mitsubishi # J 117
<b>MERCEDES BENZ</b>								
190	W201	85 - 92	4	2.0	M102.962		BIM 121	
	W201	90 - 93	4	2.3	M102.985		0 227 400 664	
	W201	89 - 91	4	2.6	M103.942		0 227 400 656	
230	W123	80 - 85	4	2.3	M102		BIM 900	
	W124	89 - 93	4	2.3	M102.982		0 227 400 664	
260	W124	89 - 92	6	2.6	M103.940		0 227 400 672	
280	W123	76 - 85	6	2.8	M110		BIM 900	
300	W124	86 - 87	6	3.0	M103.983	exc 24 valve	0 227 400 585	
	W124	87 - 89	6	3.0	M103.983	exc 24 valve	BIM 658	
	W124	89 - 93	6	3.0	M103.983	exc 24 valve	BIM 674	
	W124	89 - 91	6	3.0	M104.980	24 valve	BIM 736	
	W124	91 - 92	6	3.0	M104.980	24 valve	0 227 400 738	
380	W126	81 - 85	8	3.8	M116		BIM 042	
	M107	81 - 85	8	3.8	M116		BIM 042	
400	W140	91 - 93	8	4.2	M119.971		BIM 804	
420	W126	85 - 91	8	4.2	M116		BIM 693	
560	W126	85 - 91	8	5.6	M117		BIM 695	
	M107	85 - 89	8	5.6	M117		BIM 695	
<b>MITSUBISHI - 4 Cyl.</b>								
Colt	RE	88 - 90	4	1.6	4G32	Carb	BIM 086	Mitsubishi # J 107
Cordia	AA	83 - 84	4	1.6	4G32	Carb	BIM 076	Mitsubishi # J 152
	AB	84 - 85	4	1.6	4G32	Carb	BIM 076	Mitsubishi # J 152
	AC	85 - 89	4	1.8	4G37	Carb	BIM 076	Mitsubishi # J 152
Express/L300 (inc Starwagon)	SF	86 - 90	4	2.4	4G64	EFI	BIM 034	Mitsubishi # J 121
	SG	90 - 91	4	2.4	4G64	EFI	BIM 034	Mitsubishi # J 121
	SH	91 - 94	4	2.4	4G64	EFI	BIM 034	Mitsubishi # J 121
	SJ	94 - 98	4	2.4	4G64	EFI	BIM 034	Mitsubishi # J 121
	WA	94 - 02	4	2.0,2.4	4G63,4G64	EFI	BIM 034	Mitsubishi # J 121
Galant	HG	89 - 90	4	2.0	4G63	EFI	BIM 034	Mitsubishi # J 121
	HH	90 - 93	4	2.0	4G63	EFI	BIM 034	Mitsubishi # J 121
	HJ	93 - 95	4	2.0	4G63	EFI	BIM 034	Mitsubishi # J 121



Make / Model	Series	From To	Cyl.	Ltr.	Engine	Type	Bosch Ignition Module	Notes
<b>MITSUBISHI - 4 cyl. cont.d</b>								
<b>Lancer</b>	CA	88 - 90	4	1.5	4G15	Carb	BIM 076	Mitsubishi # J 152
	CA	88 - 90	4	1.5	4G15	EFI	BIM 034	Mitsubishi # J 121
<b>Magna</b>	TM	85 - 87	4	2.6	V5	Carb	BIM 024	
	TN	87 - 89	4	2.6	V5	Carb	BIM 024	
	TN	87 - 89	4	2.6	V5	EFI	BIM 034	Mitsubishi # J 121
	TP	89 - 92	4	2.6	V5	Carb	BIM 024	
	TP	89 - 92	4	2.6	V5	EFI	BIM 034	Mitsubishi # J 121
	TR	91 - 94	4	2.6	W5	Carb	BIM 024	
	TR	91 - 94	4	2.6	W5	EFI	BIM 034	Mitsubishi # J 121
	TS	94 - 96	4	2.6	W5	Carb	BIM 024	
	TS	94 - 96	4	2.6	W5	EFI	BIM 034	Mitsubishi # J 121
	TE	96 - 97	4	2.4	4G64	EFI	BIM 034	Mitsubishi # J 121
TF	97 - 98	4	2.4	4G64	EFI	BIM 034	Mitsubishi # J 121	
<b>Nimbus</b>	UA	84 - 85	4	1.8	4G37	Carb	BIM 076	Mitsubishi # J 152
	UB	85 - 87	4	1.8	4G37	Carb	BIM 076	Mitsubishi # J 152
	UC	87 - 92	4	1.8	4G37	Carb	BIM 076	Mitsubishi # J 152
	UF	92 - 98	4	2.4	4G64	EFI	BIM 034	Mitsubishi # J 121
<b>Pajero</b>	NA	83 - 84	4	2.6	4G54	Carb	BIM 076	Mitsubishi # J 152
	NB	84 - 85	4	2.6	4G54	Carb	BIM 076	Mitsubishi # J 152
	NC	85 - 86	4	2.6	4G54	Carb	BIM 076	Mitsubishi # J 152
	ND	86 - 87	4	2.6	4G54	Carb	BIM 076	Mitsubishi # J 152
	NE	87 - 88	4	2.6	4G54	Carb	BIM 076	Mitsubishi # J 152
	NF	88 - 89	4	2.6	4G54	Carb	BIM 076	Mitsubishi # J 152
	NG	89 - 91	4	2.6	4G54	Carb	BIM 076	Mitsubishi # J 152
	NH	91 - 93	4	2.6	4G54	Carb	BIM 076	Mitsubishi # J 152
<b>Scorpion</b>	GH,GJ	80 - 84	4	2.6	4G54	Carb	BIM 086	Mitsubishi # J 107
<b>Sigma</b>	GE	78 - 80	4	1.85,2.0			9 220 066 004	
	GH	80 - 82	4	2.0,2.6			9 220 066 004	
	GJ	82 - 84	4	2.0,2.6			9 220 066 004	
	GK	84 - 85	4	2.0,2.6			BIM 024	
	GN	85 - 87	4	2.0,2.6			BIM 024	
<b>MITSUBISHI - 6 Cyl.</b>								
<b>Express/L300 (inc Starwagon)</b>	WA	94 - 02	6	3.0	6G72	EFI	BIM 034	Mitsubishi # J 121
<b>Magna</b>	TR	93 - 94	6	3.0	6G72	EFI	BIM 034	Mitsubishi # J 121
	TS	94 - 96	6	3.0	6G72	EFI	BIM 034	Mitsubishi # J 121
<b>Pajero</b>	NF	88 - 89	6	3.0	6G72	EFI	BIM 034	Mitsubishi # J 121
	NG	89 - 91	6	3.0	6G72	EFI	BIM 034	Mitsubishi # J 121
	NH	91 - 93	6	3.0	6G72	EFI	BIM 034	Mitsubishi # J 121
	NJ	93 - 96	6	3.0	6G72	EFI	BIM 034	Mitsubishi # J 121
	NK	96 - 97	6	3.0	6G72	EFI	BIM 034	Mitsubishi # J 121
<b>Verada</b>	KR	91 - 94	6	3.0	6G72	EFI	BIM 034	Mitsubishi # J 121
	KS	94 - 96	6	3.0	6G72	EFI	BIM 034	Mitsubishi # J 121
<b>NISSAN</b>								
<b>300ZX</b>	Z32	90 - 96	6	3.0	VG30DE	DOHC	BIM 149	Power Transistor unit
	Z32	90 - 96	6	3.0	VG30DETT	DOHC	BIM 149	Power Transistor unit

Make / Model	Series	From To	Cyl.	Ltr.	Engine	Type	Bosch Ignition Module	Notes
<b>NISSAN cont.d</b>								
Bluebird	910	83 - 85	4	2.0	L20B	Carb	BIM 024	Series 2
	910	85 - 86	4	2.0	CA20	Carb	BIM 030	Series 3 - Mitsubishi # J 304
	U13	93 - 97	4	2.4	KA24E	EFI	BIM 091	
EXA Coupe	KN13	87 - 88	4	1.6	CA16DE	DOHC	BIM 084	Power Transistor unit J134
	KN13	88 - 89	4	1.8	CA18DE	DOHC	BIM 084	Power Transistor unit J134
Infiniti	G50	90 - 93	8	4.5	VH45DE	MPFI	BIM 084	2 used
NX / NX-R Coupe	B13	91 - 95	4	2.0	SR20DE		BIM 091	
Pintara [ RWD ] [ FWD ] [ FWD ]	R31	86 - 90	4	2.0	CA20E	EFI	BIM 030	Mitsubishi # J 304
	U12	89 - 92	4	2.0	CA20E	EFI	BIM 034	2 Used
	U12	89 - 92	4	2.4	KA24E	EFI	BIM 091	
Pulsar	N13	87 - 92	4	1.6	16LE	TBI	BIM 148	Delco Ignition
	N13	87 - 92	4	1.8	18LF	PFI	BIM 148	Delco Ignition
	N14	91 - 95	4	1.6	GA16DE		BIM 091	
	N14	91 - 95	4	2.0	SR20DE		BIM 091	
	N15	95 - 00	4	2.0	SR20DE		BIM 091	
Serena	C23	92 - 95	4	2.0	SR20		BIM 091	
<b>PEUGEOT</b>								
205		87 - 94	4	1.9	DFZ	EFI	BIM 123	
306		93 - 97	4	2.0	RFY	16 valve	BIM 200	
405		87 - 92	4	1.9	DFV	EFI	BIM 123	
		88 - 92	4	1.9	DKZ	EFI	BIM 123	
	Mi16	93 - 97	4	2.0	RFY	16 valve	BIM 200	
505		79 - 81	4	2.0	ZEJ	K-Jetronic	BIM 123	Bosch Ignition System only
		81 - 85	4	2.2	ZDJK	K-Jetronic	BIM 123	Bosch Ignition System only
		83 - 93	4	2.2	ZDJL	LE-Jetronic	BIM 123	Bosch Ignition System only
604		77 - 79	6	2.7	B27E	K-Jetronic	BIM 019	
<b>PORSCHE</b>								
911	964	90 - 92	6	3.3	64.01/02	Turbo	BIM 124	
	964	89 - 93	6	3.6	64.01/02	EFI (inc Turbo)	BIM 124	2 Used
	993	93 - 96	6	3.6	64.05/06	EFI	BIM 200	
	993	93 - 96	6	3.8	64.20	RS	BIM 200	
924		79 - 85	4	2.0	XK/XJ		BIM 010	Metal case unit
		80 - 83	4	2.0	M31.03	Turbo	BIM 137	Hybrid unit
928	S1	77 - 82	8	4.5		K-Jetronic	BIM 008	Metal case unit
	S1	78 - 83	8	4.7	M28.11/12	K-Jetronic	BIM 008	Metal case unit
	S2	83 - 86	8	4.7	M28.21/22	LH-Jetronic	BIM 124	Hybrid unit - 2 used
	S3	86 - 87	8	5.0	M28.45/46	32V ULP eng	BIM 124	Hybrid unit - 2 used
	S4	87 - 92	8	5.0	M28.41/42		BIM 124	Hybrid unit - 2 used
	GTS	92 - 95	8	5.4	M28.49/50		BIM 124	Hybrid unit - 2 used
944	S2	88 - 91	4	3.0	M44.41	LH-Motronic	BIM 124	twin cam 16 valve engine
968		92 - 95	4	3.0	M44.41	LH-Motronic	BIM 124	



Make / Model	Series	From To	Cyl.	Ltr.	Engine	Type	Bosch Ignition Module	Notes
<b>ROVER</b>								
416i		86 - 89	4	1.6	D16A3	EFI 16v	BIM 079	Internal unit
825i		87 - 88	6	2.5	CS25A1		BIM 902	External of Distributor
<b>SUZUKI</b>								
Swift	SF	89 - 95	4	1.3	G13A	Carb	BIM 075	Mitsubishi # J117
<b>SAAB</b>								
900		83 - 88	4	2.0	B201I	K-Jetronic	BIM 139	
		83 - 88	4	2.0	B201S	Turbo	BIM 139	
		83 - 88	4	2.0	B201L	Turbo 16v	BIM 139	
		85 - 93	4	2.0	B202I	EFI 16v	BIM 124	
9000		85 - 93	4	2.0	B202I	EFI	BIM 124	
		85 - 93	4	2.0	B202L	Turbo 16v	BIM 139	
<b>TOYOTA</b>								
Camry	SV11	82 - 86	4	2.0	2SE-C	Carb	BIM 126	
	SV20	87 - 89	4	1.8	1SE-C	TBI	BIM 126	
	SV22	87 - 91	4	2.0	3SF-C	Carb	BIM 904	
Celica	SA63	83 - 85	4	2.0	2S-C	Carb	BIM 126	
Corolla	AE80	85 - 86	4	1.3	2A-C	Carb	BIM 024	Bosch Distributor
	AE82	85 - 86	4	1.6	4A-C	Carb	BIM 024	Bosch Distributor
	AE82	86 - 88	4	1.6	4AF-E	EFI	BIM 904	Denso Distributor
	AE90	89 - 92	4	1.4	6AF-C	Carb	BIM 024	Bosch Distributor
	AE92	89 - 94	4	1.6	4AF-C	Carb	BIM 024	Bosch Distributor
	AE92	92 - 95	4	1.6	4AF-E	EFI	BIM 904	Denso Distributor
	AE95	92 - 95	4	1.6	4AF-E	EFI	BIM 904	Denso Distributor
Corona	ST141	84 - 87	4	2.0	2S-C	Carb	BIM 126	
Hi-Ace	RZH	89 - 98	4	2.4	2R-Z	Carb	BIM 904	
Hi-Lux	YN56	87 - 88	4	1.8	1Y-C	Carb	BIM 126	
	YN58	87 - 88	4	2.2	2Y-C	Carb	BIM 126	
Lexcen	VN	88 - 91	6	3.8			BIM 801	
	VP	91 - 93	6	3.8			BIM 802	
	VR	93 - 95	6	3.8			BIM 802	
	VS	95 - 97	6	3.8			BIM 802	
Tarago	YR20	82 - 86	4	2.0	2Y-C	Carb	BIM 126	
	YR21	86 - 90	4	2.0	3Y-C	Carb	BIM 126	
<b>VOLKSWAGEN</b>								
Caravelle		83 - 85	4	1.9	DH	Carb	BIM 137	Replaces "Telefunken" unit
		94 - 98	4	2.0	AAC	EFI	BIM 901	
		85 - 86	4	2.1	MV	EFI	BIM 137	Inductive trigger ignition
		86 - 92	4	2.1	MV	EFI	BIM 142	Hall trigger ignition
		92 - 93	5	2.5	AAF	EFI	BIM 901	
Golf	VR6	94 - 97	6	2.8	AAA	EFI	BIM 901	
Transporter		83 - 85	4	1.9	DH	Carb	BIM 137	Replaces "Telefunken" unit

Make / Model	Series	From To	Cyl.	Ltr.	Engine	Type	Bosch Ignition Module	Notes
<b>VOLKSWAGEN cont.d</b>								
Transporter		94 - 98	4	2.0	AAC	EFI	BIM 901	
		85 - 86	4	2.1	MV	EFI	BIM 137	Inductive trigger ignition
		86 - 92	4	2.1	MV	EFI	BIM 142	Hall trigger ignition
		92 - 93	5	2.5	AAF	EFI	BIM 901	
<b>VOLVO</b>								
240 Series		74 - 82	4	2.1	B21E	K-Jetronic	BIM 018	
		79 - 84	4	2.3	B23E	K-Jetronic	BIM 018	
		84 - 87	4	2.3	B230E	K-Jetronic	BIM 139	Hall trigger ignition
		84 - 88	4	2.3	B230F	LH-Jetronic	BIM 139	Hall trigger ignition
		88 - 93	4	2.3	B230F	LH-Jetronic	BIM 124	
260 Series		74 - 80	6	2.7	B27E	K-Jetronic	BIM 019	
		80 - 84	6	2.8	B28E	K-Jetronic	BIM 019	
740 Series		84 - 86	4	2.3	B230E	K-Jetronic	BIM 124	
		86 - 89	4	2.3	B230F	LH-Jetronic	BIM 124	
	Turbo	86 - 89	4	2.3	B230FT	LH-Jetronic	BIM 124	
		88 - 89	4	2.3	B234F	16 valve	BIM 124	
760 Series		83 - 87	6	2.8	B28E	K-Jetronic	BIM 019	
		87 - 89	6	2.8	B280F	LH-Jetronic	BIM 124	
	Turbo	87 - 89	4	2.3	B230FT	LH-Jetronic	BIM 124	
850 Series		93 - 95	5	2.5	B5252S	10 valve	0 221 601 452	Coil & Module Assy
		95 - 97	5	2.5	B5252S	10 valve	0 221 601 012	Coil & Module Assy
		93 - 95	5	2.5	B5254S	20 valve	0 221 601 452	Coil & Module Assy
		95 - 97	5	2.5	B5254S	20 valve	0 221 601 012	Coil & Module Assy
		93 - 95	5	2.3	B5234FT	Turbo	0 221 601 452	Coil & Module Assy
		95 - 97	5	2.3	B5234FT	Turbo	0 221 601 012	Coil & Module Assy
940 Series		91 - 96	4	2.3	B234F	16 valve	BIM 124	
		90 - 95	4	2.3	B230F	LH-Jetronic	BIM 124	
		90 - 96	4	2.3	B230FT	Turbo LH	BIM 124	
960 Series		90 - 91	6	2.8	B280F	LH-Jetronic	BIM 124	V6 engine
		90 - 97	6	3.0	B6304FS	Motronic	0 227 100 203	in-line engine

# **Pulse Generator Vehicle Application Guide**

Make / Model	Series	From To	Cyl.	Ltr.	Engine	Type	Bosch Pulse Generator	Notes
<b>ALFA ROMEO</b>								
<b>33</b>		87 - 88	4	1.7	AR 30550	Carb	1 234 211 018	Inductive Sensor
		87 - 89	4	1.7	AR 30550	Carb	1 234 211 029	suits BIM 140
		87 - 89	4	1.7	AR 30558	EFI	1 234 211 029	suits BIM 140
<b>75</b>		88 - 92	4	2.0	AR 06224	Twin Spark	0 261 210 036	
		86 - 90	6	2.5	AR 0911		1 237 011 063	Hall Effect Sensor
		88 - 92	6	3.0	AR 6124		1 237 011 063	Hall Effect Sensor
<b>90</b>		86 - 88	6	2.5	AR 0911		1 237 011 063	Hall Effect Sensor
<b>GTV</b>		81 - 86	4	2.0	AR 01623	Carb	1 234 211 018	Inductive Sensor
		86 - 88	6	2.5	AR 0911		1 237 011 063	Hall Effect Sensor
<b>Giulietta</b>		84 - 85	4	2.0	AR 01655	Carb	1 234 211 018	Inductive Sensor
<b>Sprint</b>		83 - 87	4	1.5	AR 30198	Carb	1 234 211 018	Inductive Sensor
<b>AUDI</b>								
<b>80</b>		83 - 86	4	1.8	JN		1 237 011 073	Hall Sensor Kit
		87 - 88	4	1.9	SD		1 237 081 180	
<b>100</b>		77 - 82	5	2.2	WC/WE		1 237 011 052	Hall Sensor Kit
		82 - 84	5	2.2	KF		1 237 011 110	Hall Sensor Kit
		84 - 89	5	2.2	HX		1 237 011 110	Hall Sensor Kit
<b>BMW</b>								
<b>318</b>	E21	80 - 83	4	1.8	184EZ	K-Jetronic	1 234 211 019	
<b>323</b>	E21	78 - 80	6	2.3	236EA	K-Jetronic	1 234 211 010	
	E21	80 - 83	6	2.3	236EA	K-Jetronic	1 234 211 019	
<b>520</b>	E28	81 - 84	6	2.0	206EA	K-Jetronic	1 234 211 019	
	E34	89 - 92	6	2.0	2060E1	Motronic	0 261 210 053	
<b>525E</b>	E28	83 - 85	6	2.7	276EB	Motronic	0 261 210 001	
	E28	85 - 87	6	2.7	276EB	Motronic	0 261 210 028	
<b>528</b>	E28	81 - 87	6	2.8	286EA	EFI	1 234 211 019	
<b>535</b>	E28	84 - 87	6	3.4	346EA/C	Motronic	0 261 210 002	Crankshaft mounted
<b>633</b>	E24	78 - 81	6	3.2	326EA	L-Jetronic	1 234 211 010	
<b>635</b>	E24	80 - 82	6	3.5	356E	Motronic	0 261 210 002	Crankshaft mounted
<b>733</b>	E23	78 - 81	6	3.2	326EA	L-Jetronic	1 234 211 010	
<b>735</b>	E24	82 - 86	6	3.4	346EA/C	Motronic	0 261 210 002	Crankshaft mounted
<b>CITREON</b>								
<b>AX</b>		91 - 92	4	1.4	KDZ		1 234 211 025	using BIM 140 Module
<b>BX</b>	19	86 - 89	4	1.9	D2E	Carb	1 234 211 028	using BIM 123 module
	19	89 - 93	4	1.9	D2F	Carb	1 234 211 025	using BIM 140 Module
	19	89 - 93	4	1.9	DFW	EFI 16 valve	0 261 210 043	Crank mounted trigger



Make / Model	Series	From To	Cyl.	Ltr.	Engine	Type	Bosch Pulse Generator	Notes
<b>DAEWOO</b>								
1.5i		94 - 95	4	1.5			BCS 803	Delco Ignition
Cielo		95 - 98	4	1.5			BCS 803	Delco Ignition
Espero		95 - 98	4	2.0			BCS 803	Delco Ignition
<b>EUNOS</b>								
30X		91 - 98	6	1.8	KF	Quad cam	BIM 089	Mitsubishi # J 885
500		92 - 98	6	2.0	KF	Quad cam	BIM 089	Mitsubishi # J 885
800		93 - 98	6	2.5	KL	Quad cam	BIM 089	Mitsubishi # J 885
<b>FIAT</b>								
Argenta		81 - 83	4	2.0	132FB	Carb & EFI	1 234 211 018	Bosch Ignition
<b>FORD - 4 Cyl.</b>								
Corsair	UA	89 - 92	4	2.0	CA20E		1 231 324 198	
Telstar	AS	85 - 87	4	2.0		Carb	9 232 067 076	Bosch Distributor
<b>FORD - 6 Cyl.</b>								
Bronco		81 - 85	6	4.1		Carb	9 231 067 083	Alloy Head Only
Cortina	TE	77 - 80	6	3.3,4.1			9 231 067 083	Alloy Head Only
	TF	80 - 83	6	3.3,4.1			9 231 067 083	Alloy Head Only
F-Series		81 - 85	6	4.1		Carb	9 231 067 083	Alloy Head Only
Falcon Incl. Utility	XD	79 - 82	6	3.3,4.1			9 231 067 083	Alloy Head Only
	XE	82 - 84	6	3.3,4.1		Carb & EFI	9 231 067 083	
	XF	84 - 86	6	3.3,4.1		Carb	9 231 067 083	Leaded Fuel Only
	XF	86 - 93	6	3.3,4.1		Carb	9 233 067 050	ULP (EST system)
	XF	84 - 88	6	4.1		EFI	9 233 067 041	
	EA	88 - 91	6	3.2,3.9		CFI	9 233 067 066	
	EA	88 - 91	6	3.9		MPFI	9 233 067 065	
	EB	91 - 92	6	3.9		CFI	9 233 067 066	
	EB	91 - 92	6	3.9		MPFI	9 233 067 065	
	EB-II	92 - 93	6	4.0		MPFI	9 233 067 065	
	ED	93 - 94	6	4.0		MPFI	9 233 067 065	
	EF	94 - 96	6	4.0		MPFI	9 335 060 000	CID/CMP Sensor
	EL	96 - 98	6	4.0		MPFI	9 233 067 065	
Fairlane	AU	98 - 02	6	4.0		MPFI	0 261 210 168	Camshaft Position Sensor
	XG	93 - 96	6	4.0		MPFI	9 233 067 065	
	XH	96 - 98	6	4.0		MPFI	9 233 067 065	
	ZJ	79 - 82	6	4.1			9 231 067 083	
	ZK	82 - 84	6	4.1		Carb & EFI	9 231 067 083	
	ZL	84 - 86	6	4.1		Carb	9 231 067 083	Leaded Fuel Only
	ZL	86 - 88	6	4.1		Carb	9 233 067 050	ULP (EST system)
	ZL	84 - 88	6	4.1		EFI	9 233 067 041	
NA	88 - 91	6	3.9		MPFI	9 233 067 065		
NC	91 - 92	6	3.9		MPFI	9 233 067 065		
NC-II	92 - 94	6	4.0		MPFI	9 233 067 065		
NF	94 - 96	6	4.0		MPFI	9 335 060 000	CID/CMP Sensor	
NL	96 - 98	6	4.0		MPFI	9 233 067 065		

Make / Model	Series	From To	Cyl.	Ltr.	Engine	Type	Bosch Pulse Generator	Notes
<b>FORD - 6 cyl. cont.d</b>								
Fairlane	AU	98 - 02	6	4.0		MPFI	0 261 210 168	Camshaft Position Sensor
LTD	FC	79 - 82	6	4.1			9 231 067 083	
	FD	82 - 84	6	4.1		Carb & EFI	9 231 067 083	
	FE	84 - 86	6	4.1		Carb	9 231 067 083	Leaded Fuel Only
	FE	86 - 88	6	4.1		Carb	9 233 067 050	ULP (EST system)
	FE	84 - 88	6	4.1		EFI	9 233 067 041	
	DA	88 - 91	6	3.9		MPFI	9 233 067 065	
	DC	91 - 92	6	3.9		MPFI	9 233 067 065	
	DC-II	92 - 94	6	4.0		MPFI	9 233 067 065	
	DF	94 - 96	6	4.0		MPFI	9 335 060 000	CID/CMP Sensor
	DL	96 - 98	6	4.0		MPFI	9 233 067 065	
	AU	98 - 02	6	4.0		MPFI	0 261 210 168	Camshaft Position Sensor
Telstar	AX	91 - 94	6	2.5	KL	Quad cam	BIM 089	Mitsubishi # J 885
	AY	94 - 95	6	2.5	KL	Quad cam	BIM 089	Mitsubishi # J 885
<b>FORD - 8 Cyl.</b>								
Bronco		81 - 85	8	4,9,5,8		Carb	9 231 067 074	
F-Series		81 - 85	8	4,9,5,8		Carb	9 231 067 074	
Falcon	XC	76 - 79	8	5.8			9 233 067 060	
	XD	79 - 82	8	4,9,5,8			9 231 067 074	
	XE	82 - 84	8	4,9,5,8			9 231 067 074	
Fairlane	ZH	76 - 79	8	5.8			9 233 067 060	
	ZJ	79 - 82	8	4,9,5,8			9 231 067 074	
	ZK	82 - 84	8	4,9,5,8			9 231 067 074	
LTD	P6 [XC]	76 - 79	8	5.8			9 233 067 060	
	FC	79 - 82	8	4,9,5,8			9 231 067 074	
	FD	82 - 84	8	4,9,5,8			9 231 067 074	
<b>HOLDEN - 4 Cyl.</b>								
Astra	LD	87 - 90	4	1.6	16LE	TBI	BCS 803	Delco Ignition
	LD	87 - 90	4	1.8	18LF	PFI	BCS 803	Delco Ignition
Calibra	YE	91 - 97	4	2.0	C20NE	DOHC (16v)	0 261 210 030	Located in Cam cover
	YE	91 - 97	4	2.0	C20XE	SOHC	0 261 210 030	Located in Cam cover
	YE	91 - 97	4	2.0	C20LET	Turbo	0 261 210 030	Located in Cam cover
Camira	JB	82 - 83	4	1.6		Carb	1 237 011 058	
	JD	83 - 87	4	1.8	18JU	EFI	1 237 011 058	Bosch Ignition
	JD	86 - 87	4	1.6		TBI	BCS 803	Delco Ignition
	JE	87 - 90	4	2.0		PFI	BCS 803	Delco Ignition
Nova	LE	90 - 92	4	1.4	4AF-C	Carb	9 232 067 076	Bosch Distributor
	LE	90 - 92	4	1.6	6AF-C	Carb	9 232 067 076	Bosch Distributor
	LF	92 - 94	4	1.4	4AF-C	Carb	9 232 067 076	Bosch Distributor
	LF	92 - 94	4	1.6	6AF-C	Carb	9 232 067 076	Bosch Distributor
<b>HOLDEN - 6 Cyl.</b>								
Calais	VK	84 - 86	6	3.3		EFI	9 231 067 083	
	VN	88 - 91	6	3.8			BCS 801	with aluminium bracket
	VP	91 - 93	6	3.8			BCS 802	Full moulded plastic unit
	VR	93 - 95	6	3.8			BCS 802	Full moulded plastic unit



Make / Model	Series	From To	Cyl.	Ltr.	Engine	Type	Bosch Pulse Generator	Notes
<b>HOLDEN - 6 cyl. cont.d</b>								
<b>Calais</b>	VS	95 - 97	6	3.8			BCS 802	Full moulded plastic unit
	VT	97 - 00	6	3.8			BCS 802	Full moulded plastic unit
	VX	00 - 02	6	3.8			BCS 802	Full moulded plastic unit
<b>Calibra</b>	YE	93 - 97	6	2.5	C25XE		0 232 103 007	
<b>Commodore [incl utility]</b>	VC	81 - 83	6	2.85,3.3			9 231 067 083	
	VH	83 - 84	6	2.85,3.3			9 231 067 083	
	VK	84 - 86	6	3.3		Carb [EST]	0 261 210 003	Crankshaft Sensor
	VK	84 - 86	6	3.3			9 231 067 083	
	VN	88 - 91	6	3.8			BCS 801	with aluminium bracket
	VG	90 - 91	6	3.8			BCS 801	with aluminium bracket
	VP	91 - 93	6	3.8			BCS 802	Full moulded plastic unit
	VR	93 - 95	6	3.8			BCS 802	Full moulded plastic unit
	VS	95 - 01	6	3.8		inc S/Charged	BCS 802	Full moulded plastic unit
	VT	97 - 00	6	3.8		inc S/Charged	BCS 802	Full moulded plastic unit
	VX	00 - 02	6	3.8		inc S/Charged	BCS 802	Full moulded plastic unit
	VU	01 - 02	6	3.8			BCS 802	Full moulded plastic unit
	WB	80 - 85	6	3.3			9 231 067 083	Ute & Van
<b>Statesman</b>	VQ-II	92 - 93	6	3.8			BCS 802	Full moulded plastic unit
	VR	93 - 95	6	3.8			BCS 802	Full moulded plastic unit
	VS	95 - 99	6	3.8		inc S/Charged	BCS 802	Full moulded plastic unit
	WH	99 - 02	6	3.8		EFI	BCS 802	Full moulded plastic unit
<b>HOLDEN - 8 Cyl.</b>								
<b>Calais</b>	VK	84 - 86	8	5.0		Carb	9 231 067 074	
	VL	86 - 88	8	5.0		Carb	9 231 067 074	
	VN	88 - 91	8	5.0		EFI	9 233 067 056	
	VP	91 - 92	8	5.0		EFI	9 233 067 056	Series 1 - 800 distributor
	VP	92 - 93	8	5.0		EFI	9 233 067 070	Series 2 - 801 distributor
	VR	93 - 95	8	5.0		EFI	9 233 067 070	
	VS	95 - 97	8	5.0		EFI	9 233 067 070	
	VT	97 - 00	8	5.0		EFI	F 005 D10 005	Series one V8 only
<b>Commodore [incl utility]</b>	VC	81 - 83	8	4.2, 5.0			9 231 067 074	
	VH	83 - 84	8	4.2, 5.0			9 231 067 074	
	VK	84 - 86	8	5.0		Carb	9 231 067 074	
	VL	86 - 88	8	5.0		Carb	9 231 067 074	
	VL	88 - 88	8	5.0		EFI	9 233 067 056	Walkinshaw GRP A
	VN	88 - 91	8	5.0		EFI	9 233 067 056	
	VG	90 - 91	8	5.0		EFI	9 233 067 056	
	VP	91 - 92	8	5.0		EFI	9 233 067 056	Series 1 - 800 distributor
	VP	92 - 93	8	5.0		EFI	9 233 067 070	Series 2 - 801 distributor
	VR	93 - 95	8	5.0		EFI	9 233 067 070	
	VS	95 - 01	8	5.0		EFI	9 233 067 070	
VT	97 - 00	8	5.0		EFI	F 005 D10 005	Series one V8 only	
WB	80 - 85	8	4.2,5.0			9 231 067 074		
<b>Statesman</b>	WB	80 - 85	8	4.2,5.0			9 231 067 074	
	VQ	91 - 92	8	5.0		EFI	9 233 067 056	Series 1 - 800 distributor
	VQ-II	92 - 93	8	5.0		EFI	9 233 067 070	Series 2 - 801 distributor
	VR	93 - 95	8	5.0		EFI	9 233 067 070	
	VS	95 - 99	8	5.0		EFI	9 233 067 070	
<b>HYUNDAI</b>								
<b>Excel</b>	X3	94 - 96	4	1.5	Alpha 4GEK	SOHC	0 261 210 099	

Make / Model	Series	From To	Cyl.	Ltr.	Engine	Type	Bosch Pulse Generator	Notes
<b>HYUNDAI cont.d</b>								
S-Coupe		92 - 95	4	1.5	Alpha 4GEK	Motronic	0 261 210 083	
<b>MAZDA</b>								
323 (inc Astina)	BG	94 - 96	6	2.0	KF	DOHC	BIM 089	Mitsubishi # J 885
626 (inc MX-6)	GE	91 - 95	6	2.5	KL	Quad cam	BIM 089	Mitsubishi # J 885
<b>MERCEDES BENZ</b>								
A160	W168	99 - 02	4	1.6	M166	LH-Motronic	0 261 210 170	
A190	W168	99 - 02	4	1.9	M166	LH-Motronic	0 261 210 170	
C240	W202	97 - 02	4	2.4	M112	LH-Motronic	0 261 210 141	
C280	W202	93 - 96	6	2.8	M104	LH-Motronic	0 261 210 085	
	W202	97 - 02	6	2.8	M104	LH-Motronic	0 261 210 141	
E240	W210	97 - 02	4	2.4	M112	LH-Motronic	0 261 210 141	
E280	W210	97 - 02	6	2.8	M112	LH-Motronic	0 261 210 141	
E320	W210	97 - 02	6	3.2	M112	LH-Motronic	0 261 210 141	
E430	W210	97 - 02	8	4.3	M113	LH-Motronic	0 261 210 141	
ML320	W163	98 - 02	6	3.2	M112	LH-Motronic	0 261 210 141	
S430	W220	98 - 02	8	4.3	M113	LH-Motronic	0 261 210 170	
SLK230	W170	98 - 02	4	2.3	M111	LH-Motronic	0 261 210 170	
SLK320	W170	00 - 02	6	3.2	M112	LH-Motronic	0 261 210 170	
190	W201	85 - 92	4	2.0	M102.962		1 234 211 015	Inductive Distributor Sensor
	W201	89 - 90	4	2.6	M103.942		0 261 210 015	Crankshaft mounted sensor
230	W123	80 - 85	4	2.3	M102		1 234 211 015	Inductive Distributor Sensor
	W124	89 - 90	4	2.3	M102.982		0 261 210 019	Crankshaft mounted sensor
260	W124	89 - 90	6	2.6	M103.940		0 261 210 015	Crankshaft mounted sensor
280	W123	76 - 85	6	2.8	M110		1 234 211 010	Inductive Distributor Sensor
300	W124	86 - 93	6	3.0	M103.983	exc 24 valve	0 261 210 015	Crankshaft mounted sensor
	W124	89 - 92	6	3.0	M104.980	24 valve	0 261 210 051	
380	W126	81 - 85	8	3.8	M116		1 234 211 010	Inductive Distributor Sensor
	M107	81 - 85	8	3.8	M116		1 234 211 010	Inductive Distributor Sensor
400	W140	91 - 93	8	4.2	M119.971		0 261 210 056	Crankshaft mounted sensor
420	W126	85 - 91	8	4.2	M116		0 261 210 021	Crankshaft mounted sensor
560	W126	85 - 91	8	5.6	M117		0 261 210 023	Crankshaft mounted sensor
	M107	85 - 89	8	5.6	M117		0 261 210 023	Crankshaft mounted sensor

Make / Model	Series	From To	Cyl.	Ltr.	Engine	Type	Bosch Ignition Module	Notes
<b>MITSUBISHI</b>								
<b>Magna</b>	TM	85 - 87	4	2.6	V5	Carb	9 232 067 076	
	TN, TP	87 - 92	4	2.6	V5	Carb	9 232 067 076	
	TN, TP	87 - 92	4	2.6	V5	EFI	9 233 067 052	
	TR, TS	91 - 96	4	2.6	W5	Carb	9 232 067 076	
	TR, TS	91 - 96	4	2.6	W5	EFI	9 233 067 052	
<b>Sigma</b>	GE	78 - 80	4	1.85,2.0			9 231 067 094	
	GH, GJ	80 - 84	4	2.0,2.6			9 231 067 094	
	GK, GN	84 - 87	4	2.0,2.6			9 232 067 076	
<b>NISSAN</b>								
<b>Bluebird</b>	910	83 - 85	4	2.0	L20B	Carb	9 232 067 076	Series 2
	910	85 - 86	4	2.0	CA20	Carb	9 233 067 003	Series 3
<b>Pintara [ RWD ] [ FWD ]</b>	R31	86 - 90	4	2.0	CA20E	EFI	9 233 067 003	
	U12	89 - 92	4	2.0	CA20E	EFI	1 231 324 198	
<b>Pulsar</b>	N13	87 - 92	4	1.6	16LE	TBI	BCS 803	Delco Ignition
	N13	87 - 92	4	1.8	18LF	PFI	BCS 803	Delco Ignition
<b>PEUGEOT</b>								
<b>205</b>		87 - 89	4	1.9	DFZ	EFI	1 234 211 028	
		89 - 94	4	1.9	DFZ	EFI	1 234 211 025	
<b>405</b>		87 - 92	4	1.9	DFV	EFI	1 234 211 028	
		88 - 92	4	1.9	DKZ	EFI	0 261 210 043	
<b>505</b>		79 - 81	4	2.0	ZEJ	K-Jetronic	1 234 211 018	Bosch Ignition System only
		81 - 83	4	2.2	ZDJK	K-Jetronic	1 234 211 018	Bosch Ignition System only
		83 - 86	4	2.2	ZDJL	LE-Jetronic	1 234 211 018	Bosch Ignition System only
		86 - 93	4	2.2	ZDJL	LE-Jetronic	1 234 211 027	Bosch Ignition System only
<b>604</b>		77 - 79	6	2.7	B27E	K-Jetronic	1 234 211 010	
<b>PORSCHE</b>								
<b>911</b>		75 - 83	6	3.0	30.	K-Jetronic	1 234 211 010	All with CDI ignition
		84 - 88	6	3.2		Motronic	0 261 210 005	Crankshaft Sensor
	964	89 - 93	6	3.6	64.01/02	EFI (inc Turbo)	0 261 210 059	Crankshaft Sensor
	993	93 - 96	6	3.6	64.05/06	EFI	0 261 210 059	with Tiptronic only
	993	93 - 96	6	3.6	64.05/06	EFI	0 261 210 136	without Tiptronic
	993	93 - 96	6	3.8	64.20	RS	0 261 210 136	
<b>924</b>		79 - 85	4	2.0	XK/XJ		1 234 211 018	
<b>928</b>	S1	77 - 82	8	4.5		K-Jetronic	1 234 211 010	Inductive Distributor Sensor
	S1	78 - 83	8	4.7	M28.11/12	K-Jetronic	1 234 211 010	Inductive Distributor Sensor
	S2	83 - 86	8	4.7	M28.21/22	EZK ignition	0 261 210 003	Crankshaft Sensor
	S3	86 - 87	8	5.0	M28.45/46	EZK ignition	0 261 210 003	Crankshaft Sensor
	S4	87 - 92	8	5.0	M28.41/42	EZK ignition	0 261 210 003	Crankshaft Sensor
	GTS	92 - 95	8	5.4	M28.49/50	EZK ignition	0 261 210 003	Crankshaft Sensor
<b>944</b>		86 - 92	4	2.5,2.7	M44.	Motronic	0 261 210 003	Crankshaft Sensor
	S2	88 - 91	4	3.0	M44.41	EZK ignition	0 261 210 003	Crankshaft Sensor
<b>968</b>		92 - 95	4	3.0	M44.41	EZK ignition	0 261 210 003	Crankshaft Sensor

Make / Model	Series	From To	Cyl.	Ltr.	Engine	Type	Bosch Ignition Module	Notes
<b>SAAB</b>								
900		83 - 87	4	2.0	B201I	K-Jetronic	1 237 011 051	
		87 - 88	4	2.0	B201I	K-Jetronic	1 237 011 111	
		94 - 98	4	2.3	B234I	LH-Jetronic	0 261 210 030	
9000		85 - 86	4	2.0	B202L	Turbo 16v	1 237 011 109	
		93 - 98	4	2.3	B234	inc Turbo & 16v	0 261 210 030	
<b>TOYOTA</b>								
Corolla	AE80	85 - 86	4	1.3	2A-C	Carb	9 232 067 076	Bosch Distributor
	AE82	85 - 86	4	1.6	4A-C	Carb	9 232 067 076	Bosch Distributor
	AE90	89 - 92	4	1.4	6AF-C	Carb	9 232 067 076	Bosch Distributor
	AE92	89 - 94	4	1.6	4AF-C	Carb	9 232 067 076	Bosch Distributor
Lexcen	VN	88 - 91	6	3.8		EFI	BCS 801	with aluminium bracket
	VP	91 - 93	6	3.8		EFI	BCS 802	Full moulded plastic unit
	VR	93 - 95	6	3.8		EFI	BCS 802	Full moulded plastic unit
	VS	95 - 97	6	3.8		EFI	BCS 802	Full moulded plastic unit
<b>VOLKSWAGEN</b>								
Caravelle		83 - 85	4	1.9	DH	Carb	1 237 011 050	
		96 - 98	4	2.0	AAC	EFI	1 237 031 180	
		86 - 90	4	2.1	MV	EFI	1 237 031 180	Hall trigger ignition
Golf	VR6	94 - 97	6	2.8	AAA	EFI	0 261 210 081	
Caravelle		83 - 85	4	1.9	DH	Carb	1 237 011 050	
		96 - 98	4	2.0	AAC	EFI	1 237 031 180	
		86 - 90	4	2.1	MV	EFI	1 237 031 180	Hall trigger ignition
<b>VOLVO</b>								
240 Series		74 - 82	4	2.1	B21E	K-Jetronic	1 234 211 018	
		79 - 84	4	2.3	B23E	K-Jetronic	1 234 211 018	
		84 - 87	4	2.3	B230E	K-Jetronic	1 237 011 070	Hall trigger ignition
		84 - 93	4	2.3	B230F	LH-Jetronic	1 237 031 184	Dist # 0 237 520 003/4
260 Series		74 - 80	6	2.7	B27E	K-Jetronic	1 234 211 010	
		80 - 84	6	2.8	B28E	K-Jetronic	1 234 211 010	
740 Series		85 - 86	4	2.3	B230E	K-Jetronic	1 237 011 070	Hall trigger ignition
		86 - 89	4	2.3	B230F	LH-Jetronic	1 235 102 003	Distributor Assembly
		85 - 86	4	2.3	B230ET	Motronic	0 261 210 003	
		86 - 89	4	2.3	B230FT	Turbo LH	1 235 102 003	Distributor Assembly
760 Series		87 - 89	4	2.3	B230FT	Turbo LH	1 235 102 003	Distributor Assembly
		83 - 87	6	2.8	B28E	K-Jetronic	1 234 211 010	
		87 - 89	6	2.8	B280F	LH-Jetronic	0 261 210 029	Crankshaft Sensor
940 Series		91 - 95	4	2.3	B230F	LH-Jetronic	1 235 102 003	Distributor Assembly
		90 - 96	4	2.3	B230FT	Turbo LH	1 235 102 003	Distributor Assembly
960 Series		90 - 91	6	2.8	B280F	LH-Jetronic	0 261 210 029	Crankshaft Sensor
		90 - 97	6	3.0	B6304FS	Motronic	0 232 101 030	Camshaft Sensor

# **Service Parts Connector Plug Kit**



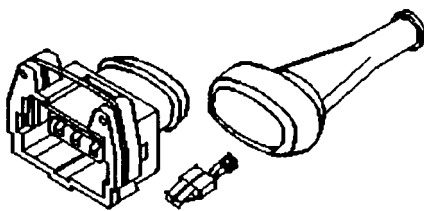
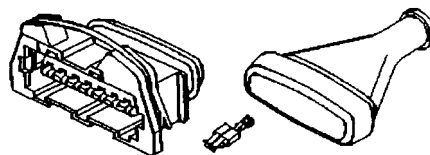
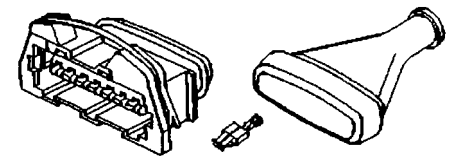

Bosch IGNITION MODULE	CONNECTOR PLUG KIT	Bosch IGNITION MODULE	CONNECTOR PLUG KIT	Bosch IGNITION MODULE	CONNECTOR PLUG KIT
0 227 100 005	1 287 013 004	0 261 210 003	1 237 000 039	BIM 019	1 224 485 020
0 227 100 006	1 224 485 020	0 261 210 030	1 237 000 039	BIM 023	1 287 013 005
0 227 100 018	1 287 013 004	0 261 210 036	1 237 000 039	BIM 027	1 287 013 005
0 227 100 019	1 224 485 020	0 261 210 043	1 237 000 039	BIM 028	1 284 485 118
0 227 100 027	1 287 013 004	0 261 210 081	1 237 000 039	BIM 034	1 237 000 039
0 227 100 100	1 287 013 005	0 261 210 083	1 237 000 039	BIM 038	1 237 000 039
0 227 100 111	1 287 013 005	0 273 200 111	1 237 000 039	BIM 111	1 287 013 005
0 227 100 118	1 287 013 005	1 227 010 003	1 287 013 005	BIM 120	1 287 013 005
0 227 100 120	1 287 013 005	1 227 010 005	1 287 013 005	BIM 123	1 287 013 005
0 227 100 123	1 287 013 005	1 227 010 039	1 287 013 005	BIM 124	1 287 013 005
0 227 100 124	1 287 013 005	1 227 022 008	1 287 013 005	BIM 127	1 287 013 004
0 227 100 137	1 287 013 005	1 227 022 017	1 237 000 039	BIM 130	1 237 000 039
0 227 100 138	1 287 013 005	1 227 022 018	1 237 000 039	BIM 137	1 287 013 005
0 227 100 139	1 287 013 005	1 227 022 028	1 284 485 118	BIM 139	1 287 013 005
0 227 100 140	1 237 000 039	1 227 022 030	1 237 000 039	BIM 140	1 237 000 039
0 227 100 142	1 287 013 005	1 227 022 031	1 237 000 039	BIM 142	1 287 013 005
0 227 100 143	1 287 013 005	1 235 102 003	1 237 000 039	BIM 145	1 287 013 005
0 227 100 145	1 287 013 005	1 237 010 038	1 237 000 039	BIM 200	1 287 013 005
0 227 100 200	1 287 013 005	1 237 081 180	1 237 000 039	BIM 901	1 237 000 039
0 227 100 203	1 287 013 005	9 220 066 004	1 224 485 020		
0 227 100 204	1 287 013 005	9 220 066 020	1 224 485 020		
0 227 100 204	1 287 013 005	9 222 067 023	1 287 013 005		
0 227 100 209	1 237 000 039 &1 284 485 118	9 222 067 027	1 287 013 005		
0 227 100 211	1 284 485 118 &1 287 013 006	9 222 067 034	1 237 000 039		
0 227 100 213	1 287 013 005	9 233 067 052	1 237 000 039		
0 261 210 002	1 237 000 039	9 233 067 070	1 237 000 039		
		BIM 002	1 287 013 005		
		BIM 018	1 287 013 004		

**3 pins**

**1 237 000 039**
**6 pins**

**1 287 013 004**
**7 pins**

**1 287 013 005**



# Illustrated Guide -

- **Ignition Modules**
- **Pulse Generators**

0 227 100 209 / 211



AUDI

9 220 066 004

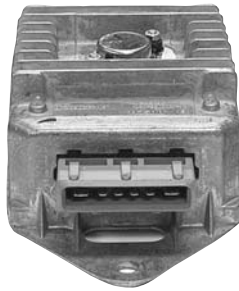

MITSUBISHI

9 220 066 020

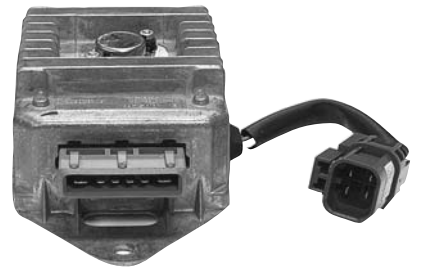

HOLDEN

BIM 018



VOLVO

BIM 019



PEUGEOT, VOLVO

BIM 023



HOLDEN

BIM 024



FORD, HOLDEN, MITSUBISHI,  
NISSAN, TOYOTA

BIM 027



HOLDEN

BIM 028



HOLDEN

BIM 030



NISSAN

BIM 032



FORD

BIM 034



FORD, HYUNDAI, MITSUBISHI

**BIM 042**



MERCEDES-BENZ

**BIM 073**



FORD, MAZDA

**BIM 075**



FORD, MAZDA, SUZUKI

**BIM 076**



DAIHATSU, HYUNDAI, MITSUBISHI

**BIM 078**

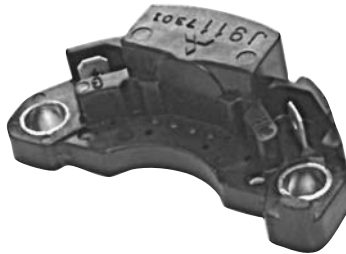

FORD, MAZDA

**BIM 079**

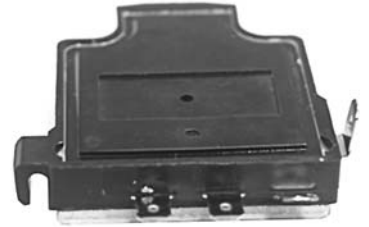

HONDA, ROVER

**BIM 084**

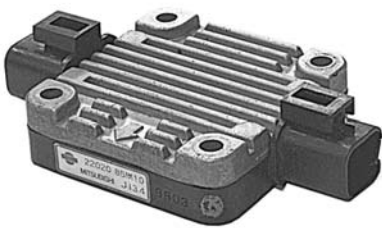

NISSAN

**BIM 085**



FORD, MAZDA

**BIM 086**

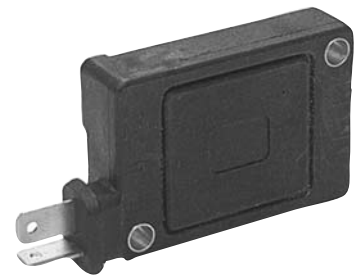

MITSUBISHI

**BIM 088**



FORD

**BIM 089**



EUNOS, FORD, MAZDA

**BIM 091**



FORD, NISSAN

**BIM 101**



FORD, MAZDA

**BIM 114 / BIM 121**



MERCEDES-BENZ

**BIM 123**

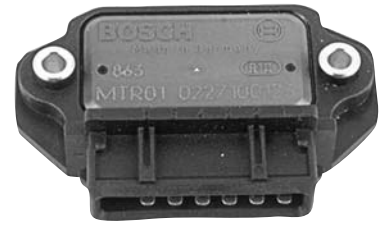

BMW, CITROEN, PEUGEOT

**BIM 126**

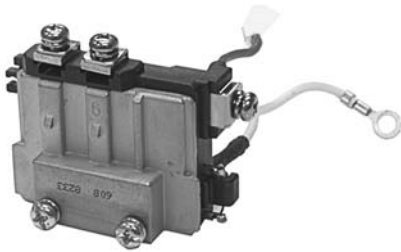

TOYOTA

**BIM 137**

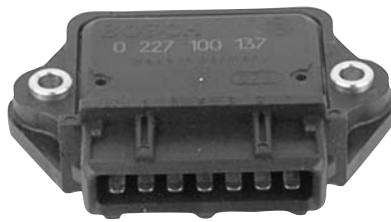

AUDI, BMW, PORSCHE,  
VOLKSWAGEN

**BIM 139**



SAAB, VOLVO

**BIM 140**



CITROEN, PEUGEOT

**BIM 142**



AUDI, VOLKSWAGEN

**BIM 148**



DAEWOO, HOLDEN, NISSAN

**BIM 200**



BMW, PEUGEOT, PORSCHE,

**BIM 801**



HOLDEN, TOYOTA

**BIM 802**

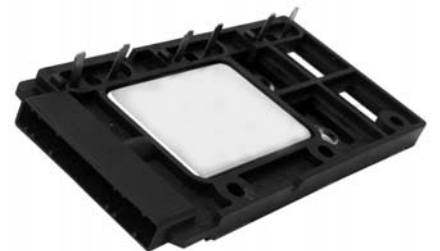

HOLDEN, TOYOTA

**BIM 901**



AUDI, VOLKSWAGEN

**BIM 902**

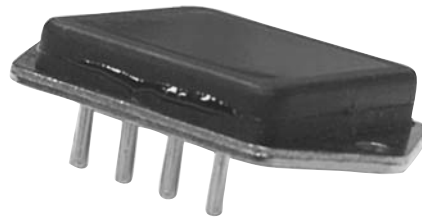

HONDA, ROVER

**BIM 904**



HOLDEN, TOYOTA

**1 234 211 018**



PEUGEOT, VOLKSWAGEN, VOLVO

**1 237 011 058**



HOLDEN

**9 231 067 074**

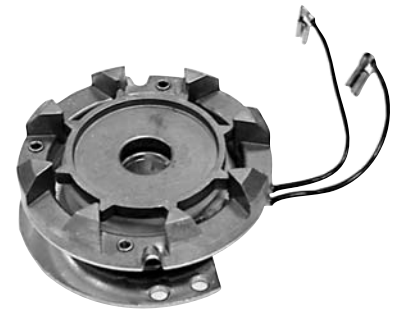

FORD, HOLDEN

**9 231 067 083**



AUDI, VOLKSWAGEN

**9 231 067 094**



HONDA, ROVER

**9 231 067 183**



CHRYSLER, DODGE TRUCKS

9 232 067 076



FORD, MITSUBISHI,  
NISSAN, TOYOTA

9 233 067 041



FORD

9 233 067 050



FORD

9 233 067 060



FORD

9 233 067 065



FORD

9 233 067 066



FORD

9 233 067 070



HOLDEN

9 335 060 000



FORD

BCS 801



HOLDEN, TOYOTA

BCS 802



HOLDEN, TOYOTA

F005 D01 005



HOLDEN